

Kave® Cares

45 min	x2	x2	x1	x1

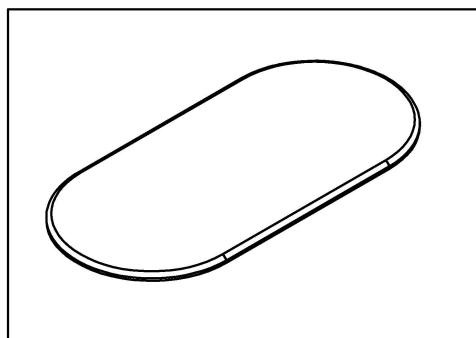

A x1

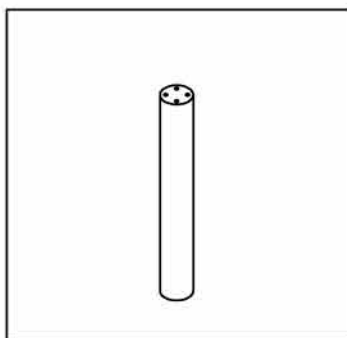

B x2

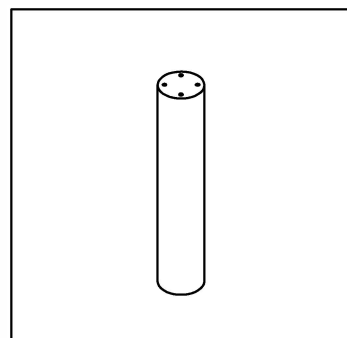

C x2

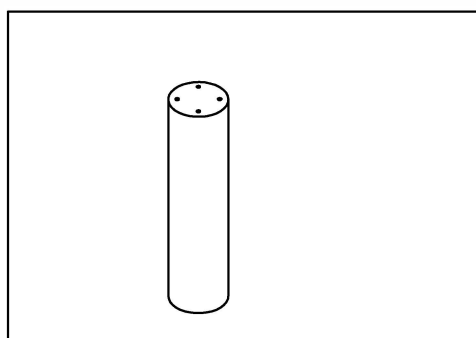

D x2

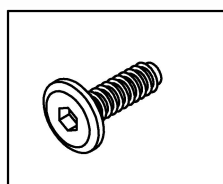

E x24
M8x25mm

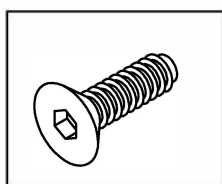

F x24
ø8 X 25mm

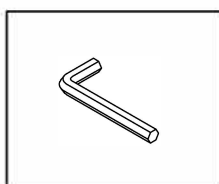

G x1
5mm

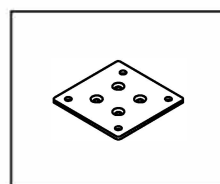

H x2
140x140*5mm

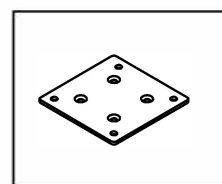

I x2
160x160*5mm

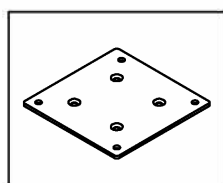

J x2
200x200*5mm

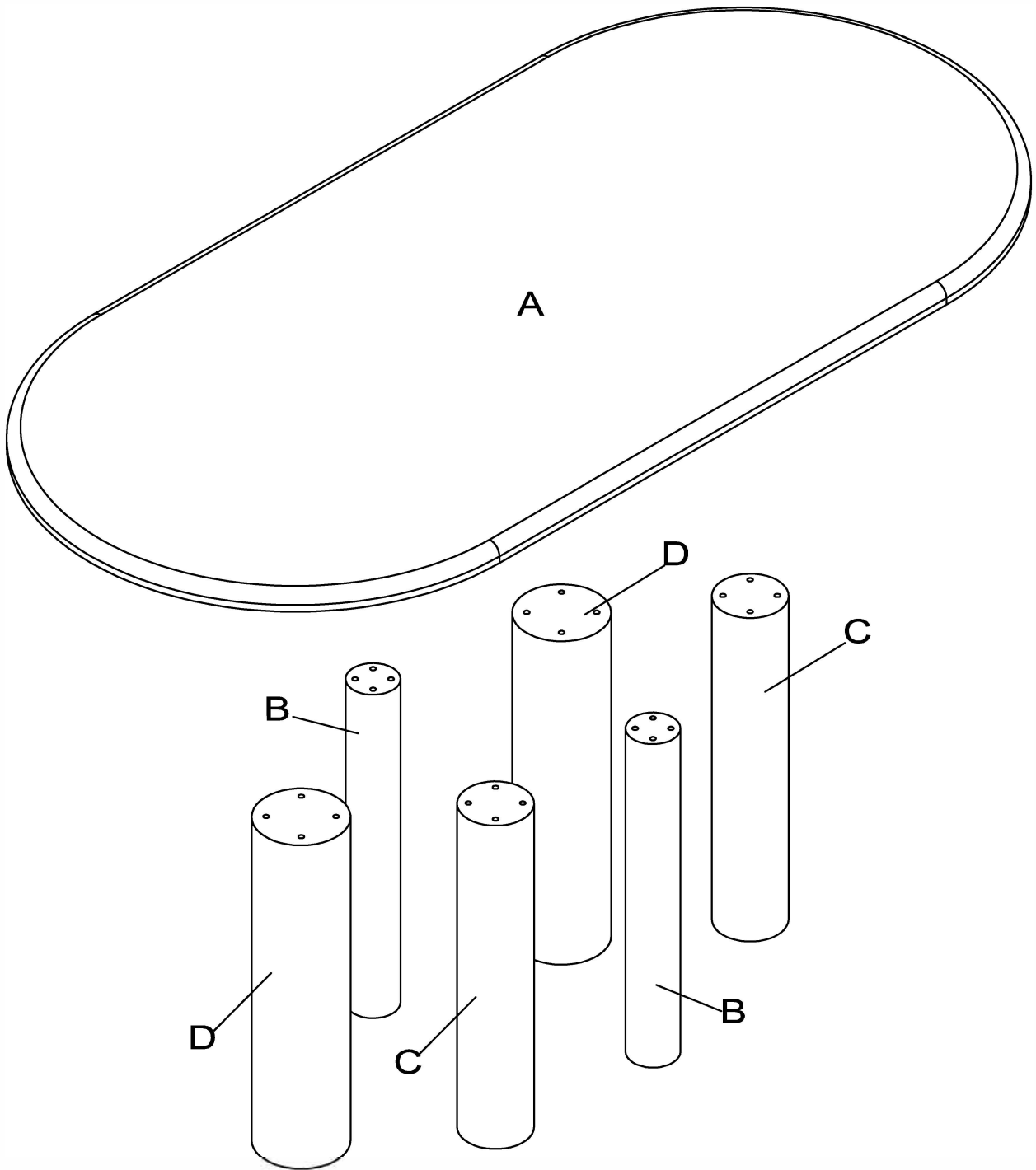

1

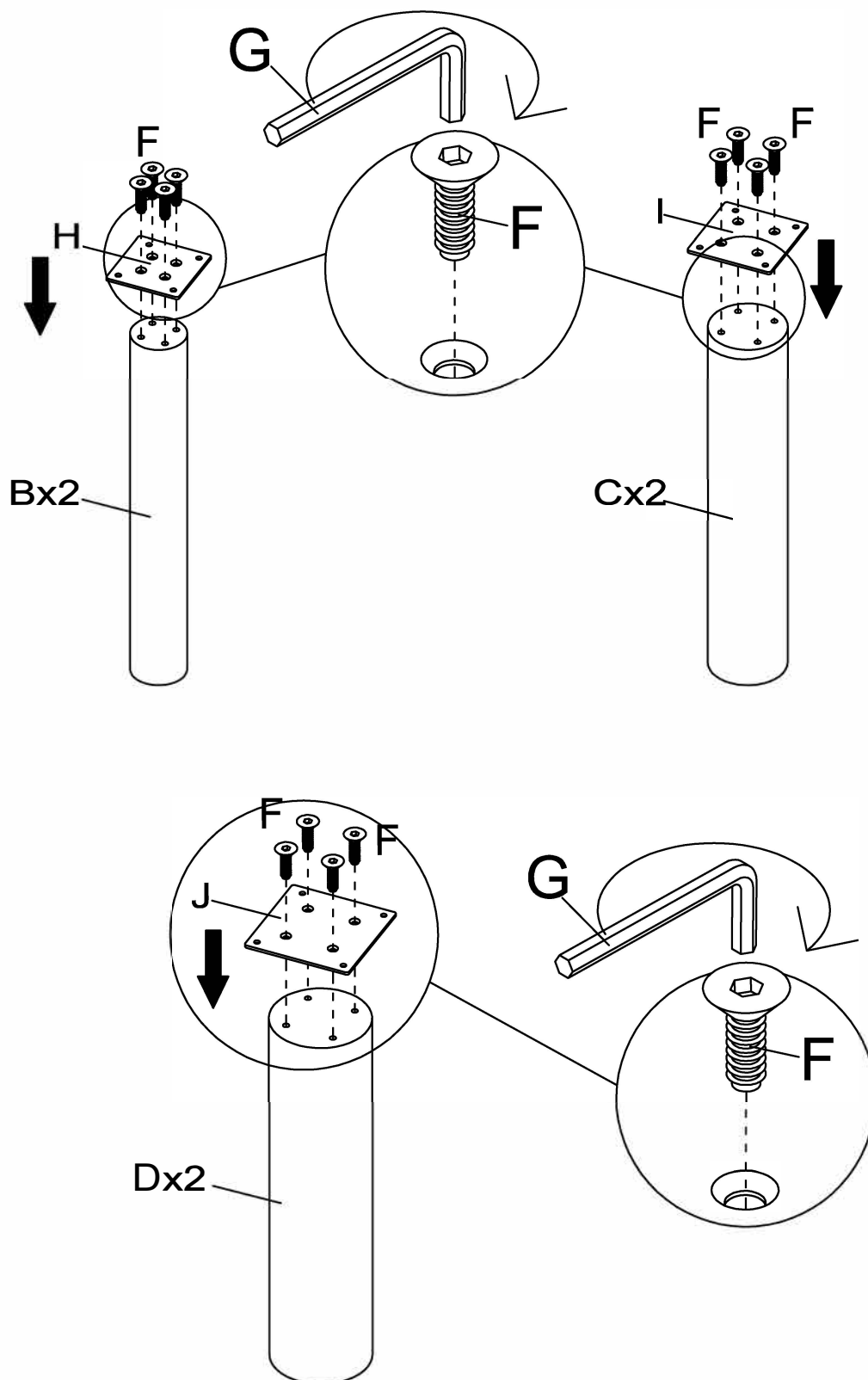

2

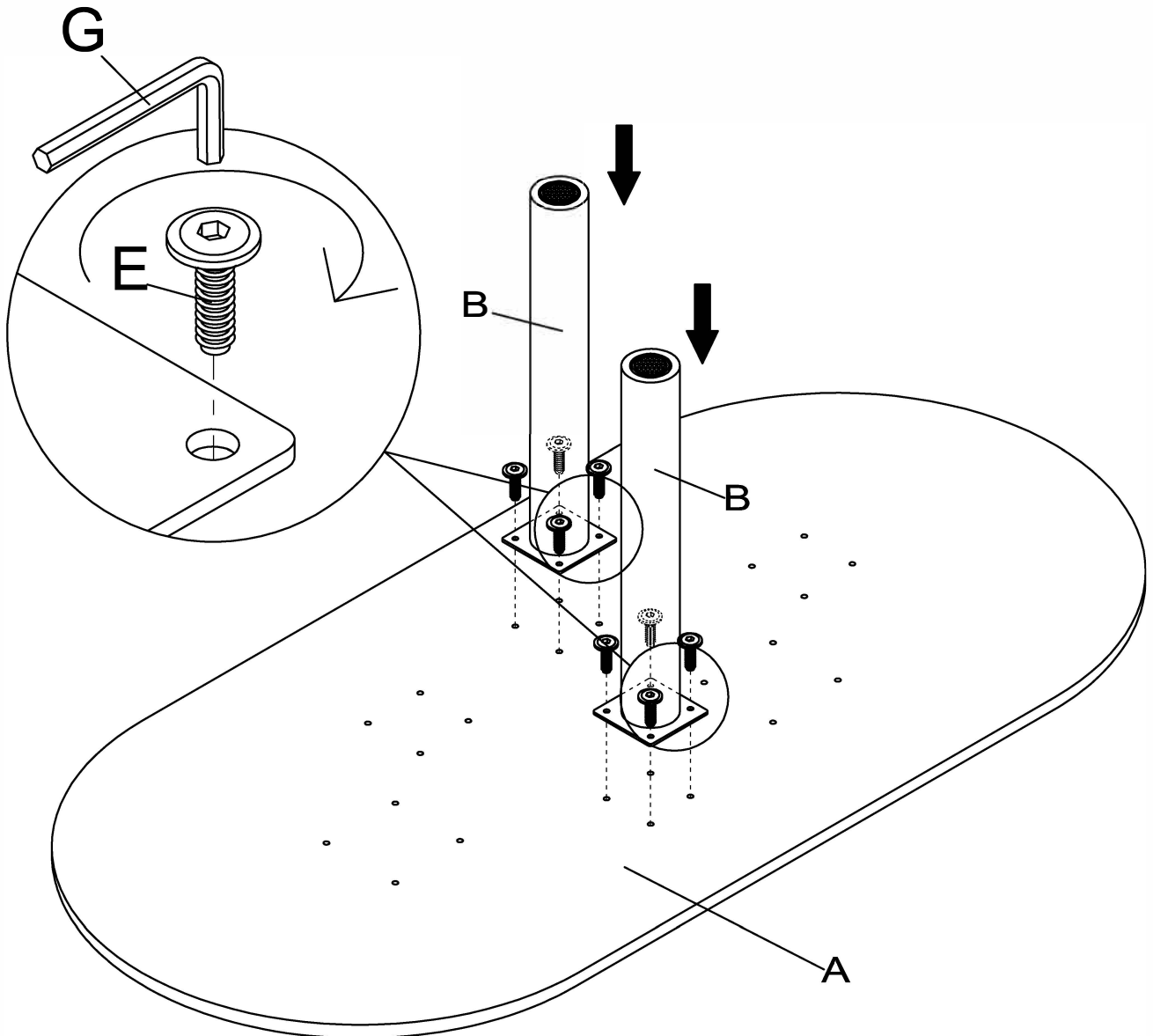

3

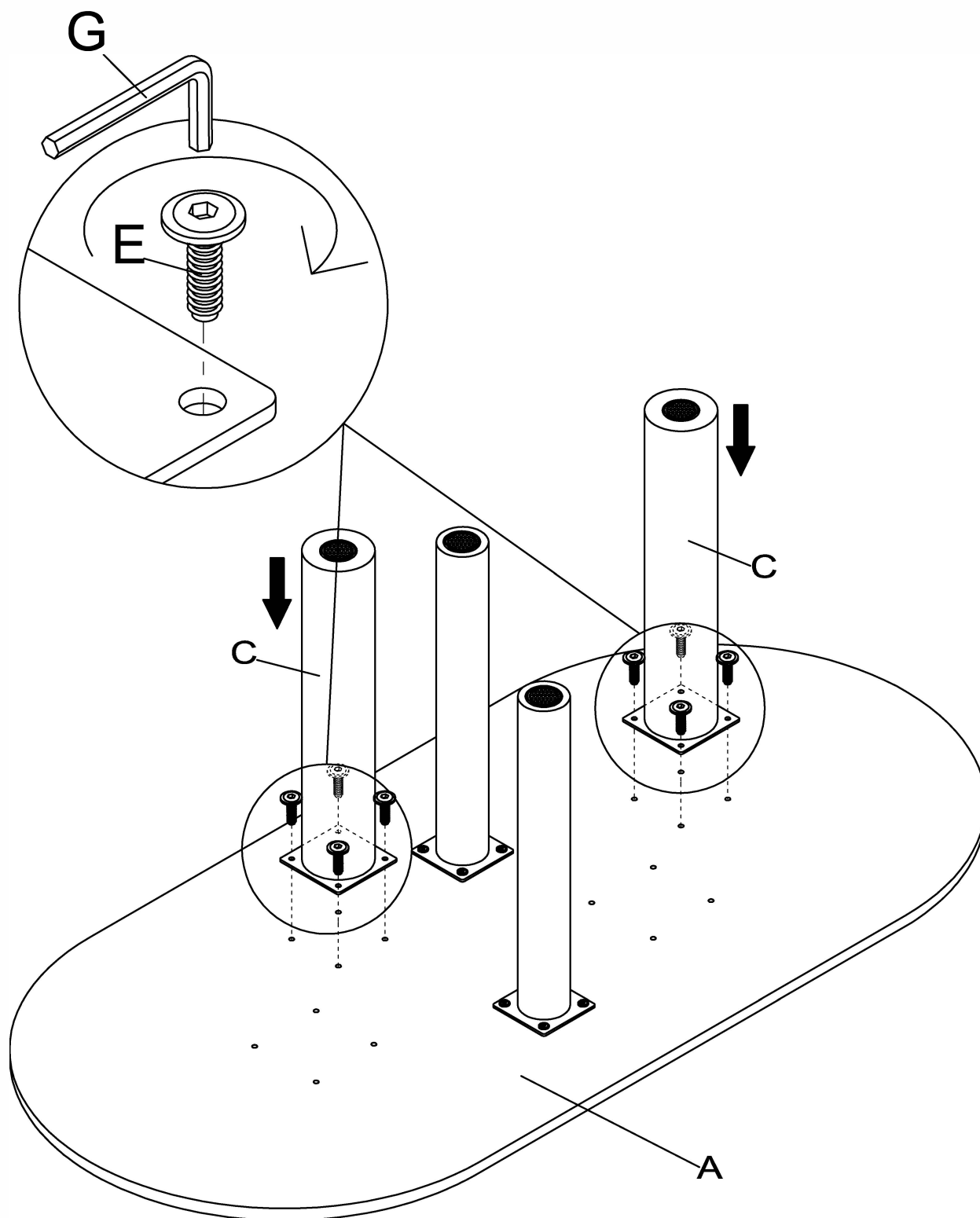

4

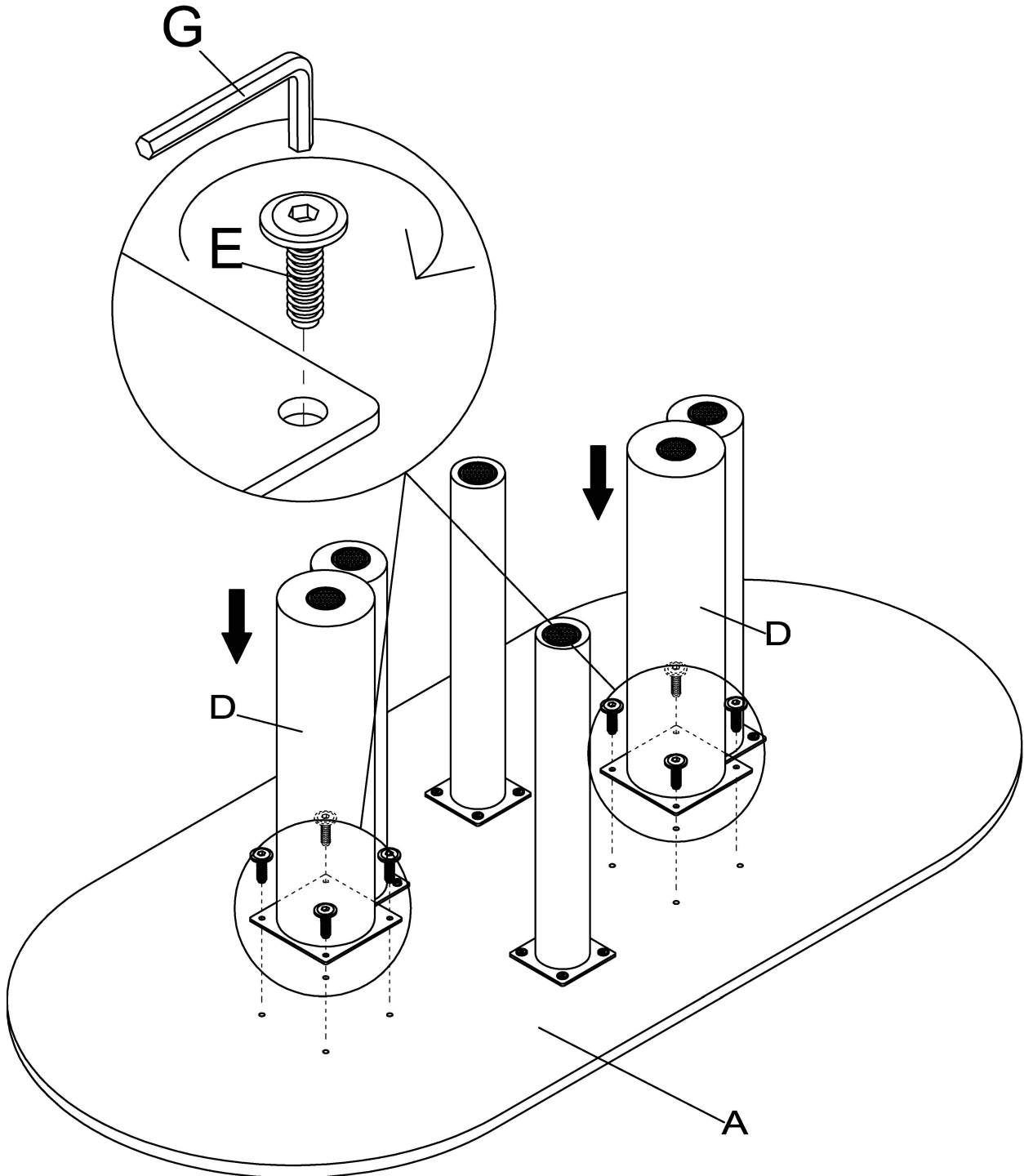

5

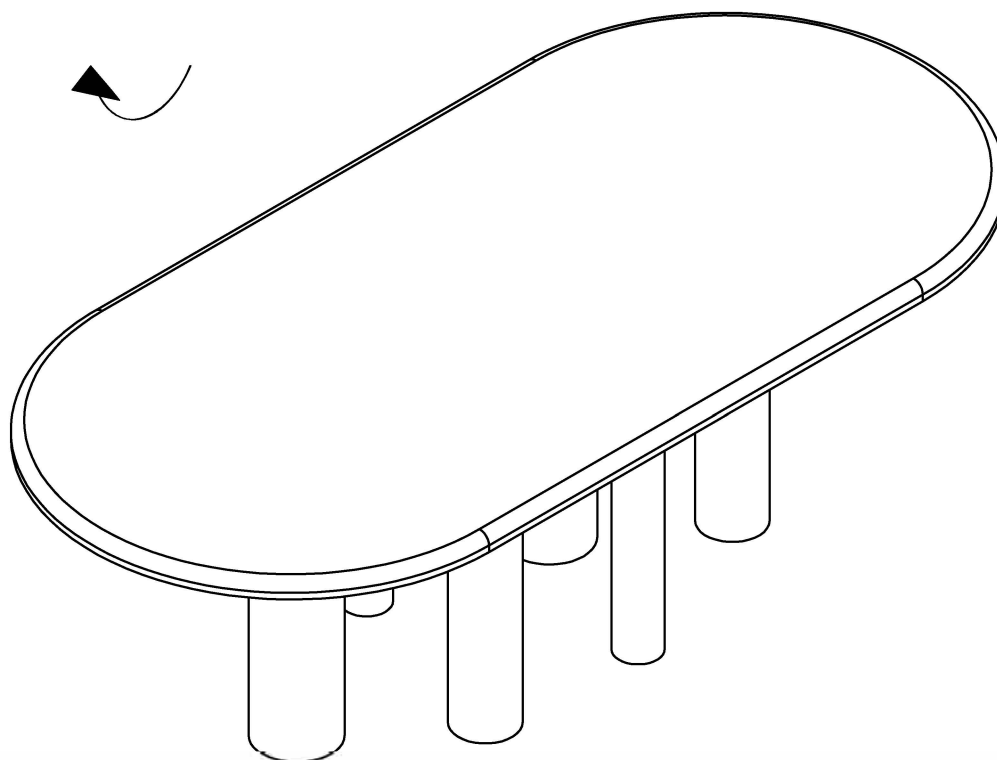
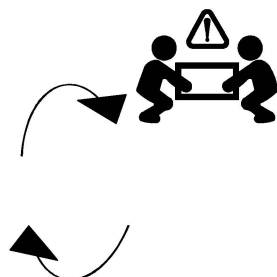
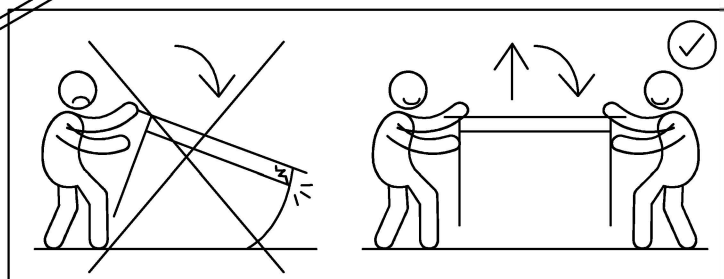
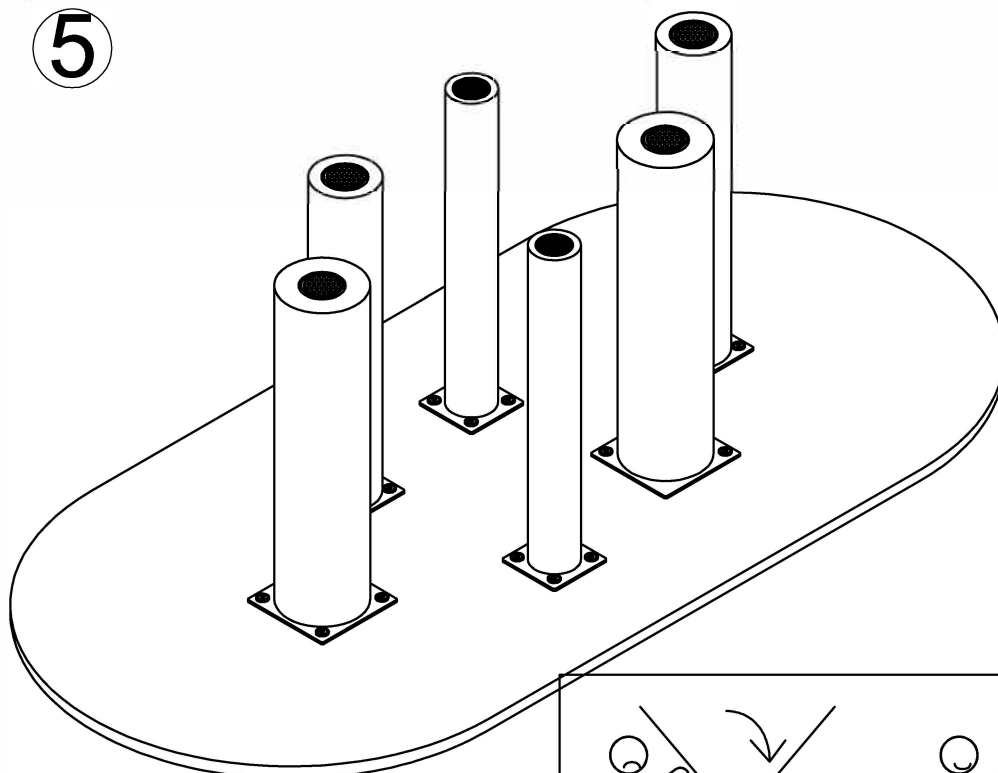



THAT'S ALL FOLKS

Share your style!

#KaveHome

