



Kave® Cares



15 min



x1



x2

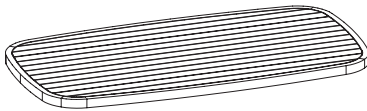

A x1



B x4



C x8



D x8



E x1

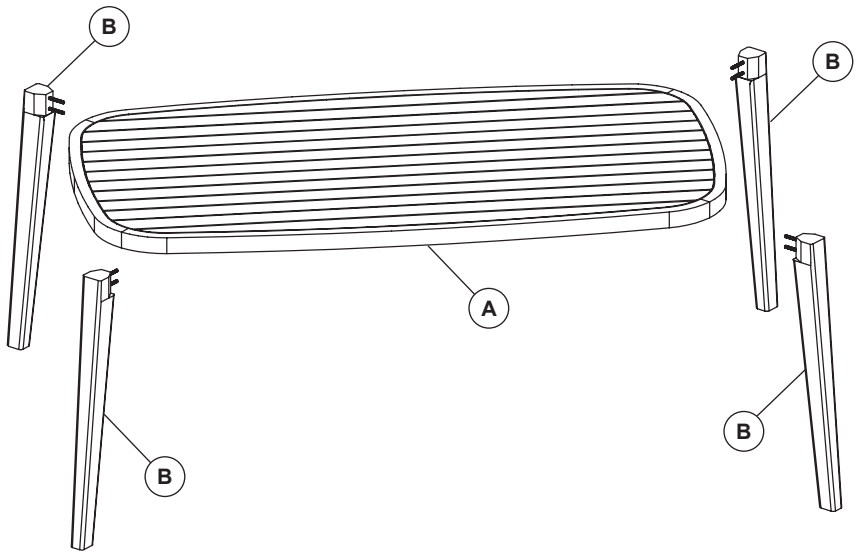

1

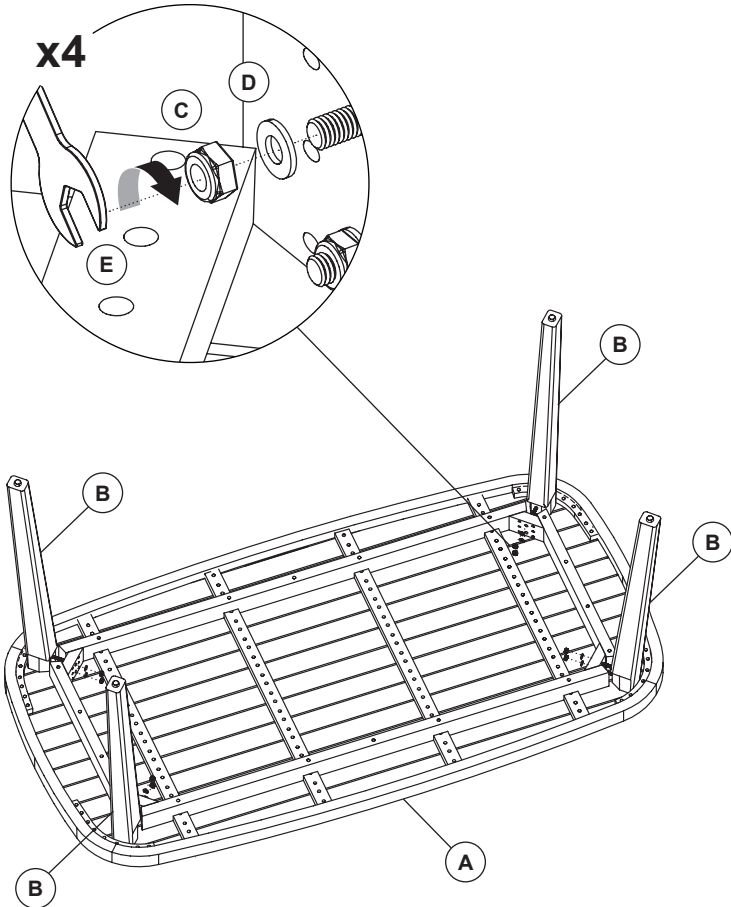

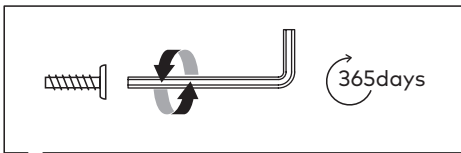
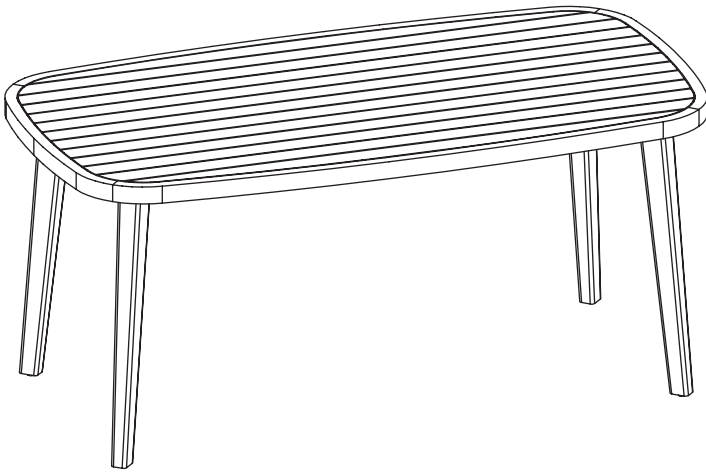



THAT'S ALL FOLKS

Share your style!

#KaveHome

